



# PRODUCT AND SERVICE

## Dust Test Chambers & Water Spray Chambers

## Company

Xi An LIB Environmental Simulation Industry manufactures and sells environmental test chambers since 2009, including design, manufacturing, as well as sales and service around the world. All LIB products have passed CE and ROHS certification, as well as other national certifications.

We deeply realized that quality is the first and most. We control quality from every aspect of raw material, production and inspection. After test chamber completed, we test its performance, inspect its functionality, go commissioning, work on calibration, and issue report for every steps, to guarantee the quality. We also pay more attention to delivery and shipment. We guarantee delivery on time, and have the obligation to advance delivery.

LIB Industry concentrates on providing the Turn-key solution for environmental testing, that research, design, producing, commissioning, delivery, install and training, provide the whole products and service according to customer's requirements..

Regarding sales, LIB direct sales and setting up local agents around the world allow customers to purchase LIB test chambers more conveniently. By 2020, our market has spread to 56 countries around the world, and the market continues to expand.

Regarding service, LIB Industry provides 3 years warranty service. In order to ensure that the customer has a timely and effective solution to the after-sales, LIB's after-sales service center and local service center work together to serve customers around the world.

We have elite team to service our customers. We provide professional solutions, right equipment, and timely reply to our worldwide customers. When we get questions and requests, we reply within 1-3 hours to our clients.

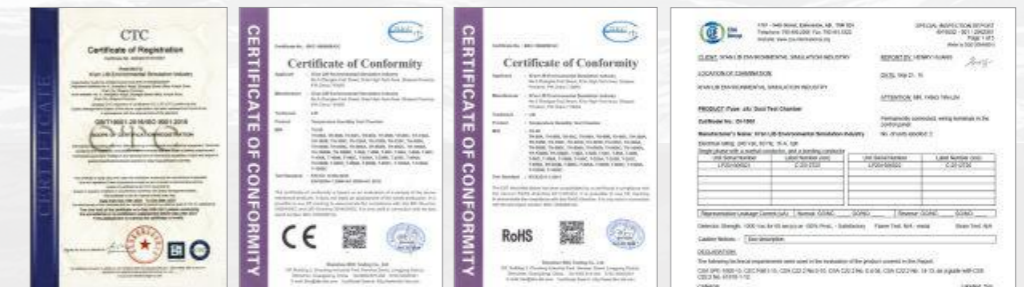

# Sand and Dust Test Chamber

LIB Sand and Dust chambers simulate an environmental condition to test the exposure of electronic components to concentrated levels of dust in order to validate product seal integrity.

Considering that the components are small and large, LIB manufactures different size and configuration of dust chambers, ranging in size from 200L to 3000L, including standard and custom chambers. All dust chambers are designed to meet test methods of IEC60529, ISO20653, IEC 60068-2-68, ASTM and MIL standards.



Large size

## Dust circulation System

Test chamber with vertical circulating airflow. The airflow can smoothly blow dust into the working room, forming a dust blowing circulation system.

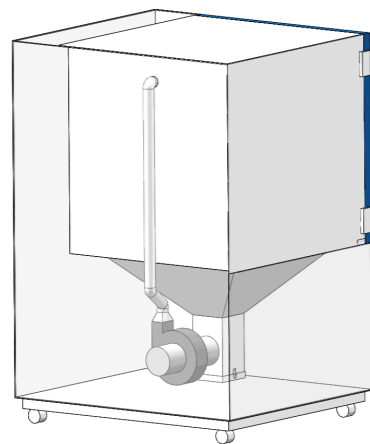

## Easy to power up the specimen

The workroom is equipped with a single-phase 16A internal power interface to power up the test specimen. The power on time and cycle can be controlled by the controller.



## Various models available

LIB designed and produced different size and configuration of dust chamber, has capacity of 800 liters, 1000 liters, 1500 liters, 2000 liters and larger volume based on various specimens.

## Specification

Model	DI-800	DI-1000	DI-1500	DI-2000
Internal Dimension (mm)	800*1000*1000	1000*1000*1000	1000*1500*1000	1000*2000*1000
Overall Dimension (mm)	1040*1450*1960	1330*1450*1960	1330*1950*1990	1330*2450*1990
Useful Volume (L)	800	1000	1500	2000
Temperature Range	Ambient ~ +50°C			
Humidity Range	< 30% RH			
Normal Wire Diameter	50um			
Nominal Width of a Gap Between wires	75um			
Fight Time	0 ~ 99H59M			
Blowing Time	0 ~ 99H59M			
Specimen Power Outlet	Dust-proof socket 16A			
Heating Element	Nichrome heater			
Vacuum System	Equipped with a pressure gauge, air filter, pressure regulator, connecting tube			
Controller	Programmable color LCD touch screen controller, Ethernet connection			
Door Lock	Electromagnetic lock			
Safety Device	Over-temperature Protection; Over-current Protection; Earth Leakage Protection; Phase Sequence Protection			
Exterior Material	A3 Steel Plate with protective coating			
Interior Material	SUS304 stainless steel			
Observation Window	Interior lighting, double-layer thermo stability silicone rubber sealing			
Standard Configuration	Sample shelf, dust wiper, talcum powder(5kgs)			
Power Supply	380V 50Hz			



# IPX1 IPX2 IPX3 IPX4 Water Spray Test Chamber

LIB has a line of water spray chambers to test the IPX1, X2, IPX3 and IPX4 protection degree against rain and sprays according to IEC 60529 and other international standards.

The water spray Chamber built with water re-circulation system that reduced water use and a series of water pipes. Incorporated rotating turntable can promote even spray of water over the surface of the products under testing. Automatic water supply ensures adequate supply of water and automatic testing. All models are upgrade to programmable controller and Ethernet access that provides simple operation and control. Its waterproof power connector in the test room can easily supply electricity to the specimens.

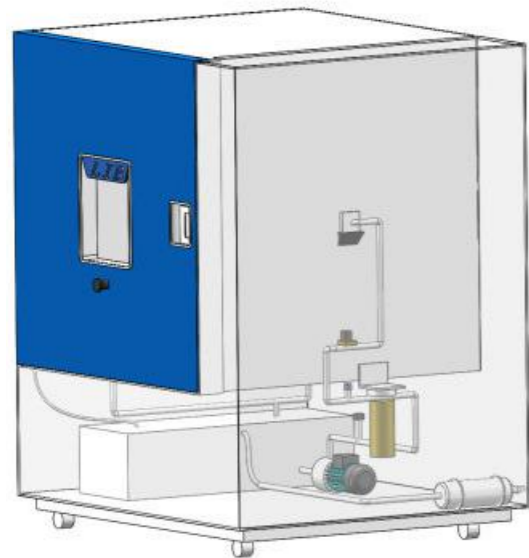

### Water purification system

LIB specially designed a set of automatic water inlet and water filtration system to filter impurities within 0.03mm particles, which has ensured the smoothness of the spray system.



### Save water

Water re-circulation system that reduced water use.

### Material anti-corrosion treatment

The material of the working room is SUS304 stainless steel, all welded surfaces and cross-sectional surfaces have been pickled to prevent rust.

### Drip tray

The drip tray is placed above the workroom to achieve IPX1 X2 drip test.

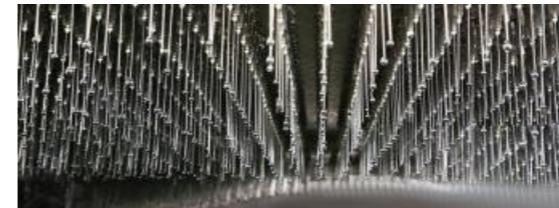

### Oscillating Tube

The oscillating tube can swing from 0 to 180° to achieve IPX3 X4 test.



### Specification

Model	R-800C	R-1200C
Internal Dimension (mm)	900*950*950	1300*1350*1370
Overall Dimension (mm)	1180*1420*1920	1540*1820*2200
Useful Volume (L)	810	2400
Oscillating Tube Radius	400mm	600mm
Drip Tray Size	600*600	1000*1000
Spraying Hole Diameter	φ0.4mm	
Hole Spacing	50 mm	
Swing Angle of Oscillating Tube	0 ~ ±180° (Adjustable)	
Turntable Rotation Speed	1r/min (Adjustable speed)	
Water Pressure Control	Flow meter	
Controller	Programmable color LCD touch screen controller, Ethernet connection, USB port	
Water supply system	Water tank, booster pump, Automatic water supply, Water purification system	
Safety Device	Over-temperature Protection; Over-current Protection; Water Shortage Protection; Earth leakage Protection; Phase Sequence Protection	
Exterior Material	Steel Plate with protective coating	
Interior Material	SUS304 stainless steel	
Observation Window	Double layer insulating glass with wiper	
Power Supply	AC380V 50Hz	

# IPX5 IPX6 Water Jetting Test Chamber

IPX5 IPX6 Water Jetting Test Chamber is applied to test the IPX5 and IPX6 protection degree against water jetting according to IEC 60529.

## Spray nozzle

Water is sprayed from IP5X and IP6X nozzles, and the flow rate is controlled by electromagnetic flowmeter.



## Specification

Model	R56-800
Workroom dimension (mm)	800*800*800
External dimension (mm)	950*3150*1800
Interior Volume (L)	510
Diameter of Turntable (mm)	600
Turntable Rotation Speed	0~7r/min (Adjustable)
Internal Diameter of IPX5 Nozzle	6.3mm
Internal Diameter of IPX6 Nozzle	12.5mm
Water Flow Rate IPX5/ IPX6	12.5L/min ±5% / 100L/min ±5%
Controller	Programmable color LCD touch screen controller, Ethernet connection
Water Supply System	Water tank, booster pump, Automatic water supply, Water purification system
Safety Device	Over-temperature Protection; Over-current Protection; Water Shortage Protection; Earth leakage Protection; Phase Sequence Protection
Exterior Material	Steel Plate with protective coating
Interior Material	SUS304 stainless steel
Observation Window	Double layer insulating glass with wiper
Power Supply	380V 50Hz

# Combined Chamber (IPX1 X2 X3 X4 X5 X6)

It is employed for combined IPX1 X2 X3 X4 X5 X6 test. This chamber combined the conditions of IPX1 ~ X6 in one chamber.



### Specification

Model	RD-800C	RD-1200C
Internal Dimension (mm)	900*950*950	1300*1350*1370
Overall Dimension (mm)	1180*1420*1920 (excluding stainless steel tube)	1540*1820*2200 (excluding stainless steel tube)
Useful Volume (L)	810	2400
Drip Tray Size	600*600	1000*1000
Oscillating Tube Radius	400mm	600mm
Water Jetting Tube		
Spraying Hole Diameter	φ0.4mm	
Hole Spacing	50 mm	
Swing Angle of Oscillating Tube	0 ~ ±180° (Adjustable)	
Jet nozzles	IPX5: Dia6.3mm, IPX6: Dia12.5mm	
Jet distance	2.5~3meter	
Turntable Rotation Speed	1r/min (Adjustable speed)	
Water Pressure Control	Flow meter	
Controller	Programmable color LCD touch screen controller, Ethernet connection, USB port	
Water supply system	Water tank, booster pump, Automatic water supply, Water purification system	
Safety Device	Over-temperature Protection; Over-current Protection; Water Shortage Protection; Earth leakage Protection; Phase Sequence Protection	
Exterior Material	Steel Plate with protective coating	
Interior Material	SUS304 stainless steel	
Observation Window	Double layer insulating glass with wiper	
Power Supply	AC380V 50Hz	

## IPX7 IPX8 Water Immersion Test Equipment

IPX7 X8 water immersion test equipment is used for water immersion testing of specimen under IPX7 and IPX8 ratings.

### Fixing device for safety

The tank is of cylindrical design, and the bottom must be supported by a tripod. Designed a Z-shaped foot with three M8 holes, which has good grip and requires user to fix the equipment with screws to ensure safety.

### Sample holder

We have designed a height-adjustable sample holder to prevent the sample from floating during the immersion test.

### Pressure limiting protection

An independent manual setting pressure limiting device is specially designed to ensure effective control of the pressure in the tank.



### Specification

Model	R78-600
Internal Dimension (mm)	Diameter 600mm * Height 1500 mm
Overall Dimension (mm)	Diameter 800mm * Height 1800 mm
Pressure	50m water depth pressure
Open mode	Pneumatic lid
Material	A3 steel plate, wall thickness 15mm
Controller	Programmable color display touch screen controller
Water Supply System	Storage water tank, Automatic water supply
Power	AC380V 50Hz



# IPX9K High Pressure & Temperature Water Spray Chamber

IPX9K high pressure and high temperature water spray test chamber is widely used in the electronics, military and consumer product industries. IPX9K is the highest rating currently available for water ingress protection in accordance with IEC 60529 and ISO 20653.

Products under test is subjected to high pressure (8000 – 10000 Kpa), high temperature (+80°C) and water jets at a flow rate of 14 – 16L/min.

All models are upgrade to programmable controller and Ethernet access that provides simple operation and control.



### Water jet in different angles

The samples can be placed at four angles (0°, 30°, 60°, 90°) for high temperature and high pressure water jetting test.

### Fixing device for test specimen

When high-pressure water is sprayed, the test specimen on the turntable will be washed away from the turntable. We specially designed M6 screw holes with a spacing of 5cm and screws to fix the specimens.



### Specification

Model	R9K-1200
Internal Dimensions (mm)	1000*1200*1000
Overall Dimensions (mm)	1250*1700*2050
Interior Volume (L)	1200
Water Spray Angle	0°, 30°, 60°, 90°
Water Spray Temperature	Ambient ~ +88°C (Adjustable)
Spray Nozzle	Four, 30 Seconds each position
Distance from Water Spraying to Specimens	10~15cm
Water Pressure	8000-10000 Kpa (Adjustable)
Water Flow Rate	14L-16L/min
Testing Platform Speed	5±1 r.p.m
Testing Platform Height	200-400 mm (Adjustable)
Testing Platform Diameters	600mm
Heater Elements	Nichrome heater
Controller	Programmable color LCD touch screen controller, Ethernet connection
Door Lock	Electromagnetic lock
Water supply system	Storage water tank; Booster pump; Automatic water supply; Water purification system;
Safety Device	Over-temperature Protection; Over-current Protection; Water Shortage Protection; Earth leakage Protection; Phase Sequence Protection
Exterior Material	Steel Plate with protective coating
Interior Material	SUS304 stainless steel
Observation Window	Double layer insulating glass with wiper
Power Supply	380V 50Hz

# JIS D 0203 Rain and Spray Test Chamber

The rain and spray test chamber is formulated in accordance with JIS D 0203 standard to test the waterproof performance of the product.

The workroom is equipped with 40 spray nozzles and 2 rain nozzles, and the spray room is equipped with water circulation system to reduce water consumption and effectively save water resources.



### Spray nozzle and rain nozzle

40 spray nozzles and 2 rain nozzles for water resistance test.



### Specification

Model	R-1000JIS
Internal Dimensions (mm)	1000*1000*1000 D*W*H
Overall Dimensions (mm)	1100*1460*1900 D*W*H
Interior Volume (L)	1000
Distance from Specimen to Nozzle	Approx.400mm
Rain Nozzle	2 holes
Rain Nozzle Hole	Φ0.5mm
R1 Water Flow Rate	1.9L/min.
R2 Water Flow Rate	3.3L/min.
Spray Nozzle	40 holes
Spray Nozzle Hole	Φ1.2mm
S1 Water Flow Rate	24.5L/min
S2 Water Flow Rate	39.2L/min
Water Pressure at Nozzle	0.03 ~ 0.30MPA
Turntable Rotation Speed	17r/min
Water Pressure Control	Flow meter
Controller	Programmable color LCD touch screen controller, Ethernet connection
Build-in Water Tank(mm)	370*375*950
View Window Size(mm)	475*475
Water supply system	Water tank, booster pump, Automatic water supply, Water purification system
Safety Device	Over-temperature Protection; Over-current Protection; Water Shortage Protection; Earth leakage Protection; Phase Sequence Protection
Exterior Material	Steel Plate with protective coating
Interior Material	SUS304 stainless steel
Observation Window	Double layer insulating glass with wiper
Power Supply	380V 50Hz

# Whole Set of IP Test Equipment No Housing Type

This IP Test Equipment is mainly suitable for water ingress testing of various specimens in the laboratory. A complete set of equipment can perform all tests from IPX1 to IPX6.

This test equipment is adjustable and can test a variety of products without being limited by size.

Comprehensive testing and affordable make this device very popular.



RNH-12 (IPX1X2 Test Equipment)

### Specification

Model	RNH-12 (IPX1X2 Test Equipment)
IPX1X2 Drip Tray(mm)	1400(D)*1400(W)
IPX1X2 External Shelf	1600(D)*1600(W)*2500(H)
Water flow rate	1+/-0.5mm/min for IPX1;3+/-0.5mm/min for IPX2
IPX1X2 hole diameters	φ0.4mm
IPX1X2 hole spacing	20mm
Turntable dimensions (mm)	600mm
Turntable loads	50KG
Water supply system	Booster pump, Water purification system



RNH34 (IPX3X4 Test Equipment)



RNH-56 (IPX5X6 Test Equipment)

### Specification

Model	RNH34 (IPX3X4 Test Equipment)
Controller	Programmable color touch screen controller, Ethernet for PC link
Standard	IEC60529
Material	SUS304 stainless steel
IPX3X4 oscillating tube radius	8pcs. (200mm, 400mm, 600mm, 800mm, 1000mm, 1200mm, 1400mm, 1600mm)
IPX3X4 flow rate per hole	0.07L/min
IPX3X4 spraying hole diameters	φ0.4mm
Hole spacing	50mm
Turntable dimensions (mm)	600mm
Turntable loads	50KG
Water supply	Water purification system

### Specification

Model	RNH-56 (IPX5X6 Test Equipment)
Controller	Programmable color touch screen controller, Ethernet
Water tank (mm)	800*800*800
Standard	IEC60529
Material	SUS304 stainless steel
Diameter of nozzle	IPX5 nozzle 6.3mm; IPX6 nozzle 12.5mm.
Water flow rate	12.5L/min for IPX5, 100L/min for IPX6
Turntable dimensions (mm)	600mm
Turntable loads	50KG



# MIL-STD- 810H Sand and Dust Test Chamber

TEMPERATURE: 10°C ~ 80°C  
 BLOWING DUST: 10.7±7g/ m<sup>3</sup>  
 BLOWING SAND: 0.18+0.2g/m<sup>3</sup>; 1.1+0.3g/m<sup>3</sup>; 2.2+0.5g/m<sup>3</sup>  
 Size can be customized according to the requirements.

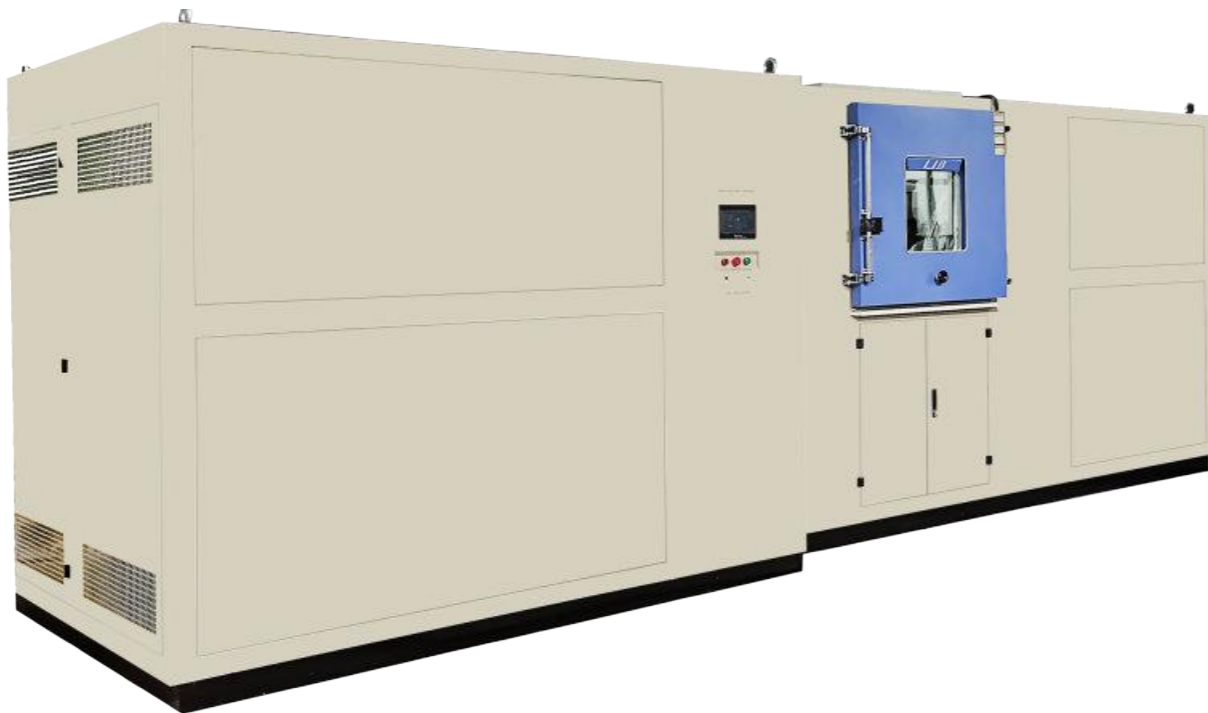

## Specification

Model	DIM-1000
Internal Dimension	1000*1000*1000mm D*W*H
Overall Dimension	3000*6100*2200mm D*W*H
Interior Volume	1000L
Blowing Dust	
Air velocity	1.5 - 8.9m/s
Concentration of dust	10.7±7g/ m <sup>3</sup>
Dust particles	< 150µm
Blowing sand	
Air velocity	18.0 - 29.0m/s
Concentration of sand	0.18+0.2g/m <sup>3</sup> ; 1.1+0.3g/m <sup>3</sup> ; 2.2+0.5g/m <sup>3</sup>
Sand particles	149µm - 600µm, 600µm - 850µm
Controller	Programmable color LCD touch screen controller, Ethernet connection
Testing Platform Diameter	600mm
Door Lock	Electromagnetic lock
Testing Platform Speed	1-7 r.p.m
Dust Detector	Integrated dust detector
Exterior Material	A3 Steel Plate with protective coating
Interior Material	SUS304 stainless steel
Standard	MIL-STD- 810H

# MIL-STD- 810H Rain Chamber

TEMPERATURE: Ambient ~ 80°C  
 RAIN AND BLOWING RAIN: 1.7 mm/min Air velocity 9m/s on test item  
 EXAGGERATED: 20.8 L/min Pressure 276 kpa  
 DRIP: 280 L/m<sup>2</sup>/hr  
 Size can be customized according to the requirements.

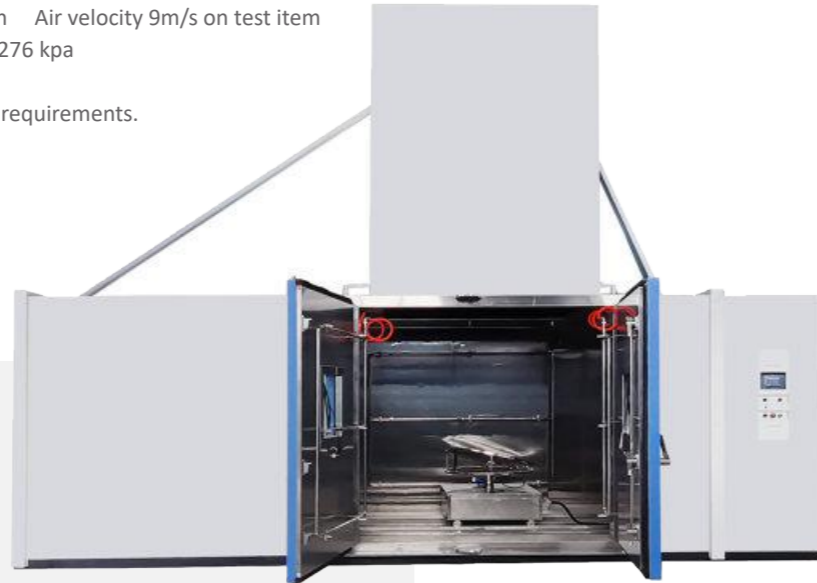

## Specification

Model	DIM-1000
Internal Dimension	1000*1000*1000 mm D*W*H
Overall Dimension	2600*5400*4100 D*W*H
Interior Volume	1000L
The load Turntable	50kg
The diameter of Turntable	800mm
Rain and Blowing Rain	
Final rain droplet velocity	9m/s on test item
Rainfall rate	≥ 1.7 mm/min
Droplet size	0.5mm ~ 4.5mm
Test specimen heating range	Water temperature +10°C (max +55°C)
Test time	0 ~ 999min. adjustable
Exaggerated	
Nozzle pressure	276kpa
Rainfall rate	20.8L/min
Nozzle amount	One nozzle for each 0.56m <sup>2</sup> of surface area and position each about 48cm from in the test surface
Droplet size	0.5mm ~ 4.5mm
Test time	0 ~ 999min. adjustable
Drip	
Drip area dimensions	1600*1000mm , height can be adjustable
Drip holes	20 to 25.4mm
Distance between hole	25mm
Volume of water	≥280L/m <sup>2</sup> /h
Test specimen heating range	Water temperature +10°C (max +55°C)
Door Lock	Electromagnetic lock
Exterior Material	A3 Steel Plate with protective coating
Interior Material	SUS304 stainless steel
Standard	MIL-STD- 810H

## Build a New IP laboratory for You

- 1 Tell us about your requirements
- 2 We provide solutions for you, to make a standard test chamber or design a custom chamber
- 3 Arrange the production of IP chambers, included dust and water ingress chambers
- 4 Inspection and issue test report
- 5 Packing and ship to laboratory
- 6 On site installation, commisioning and training

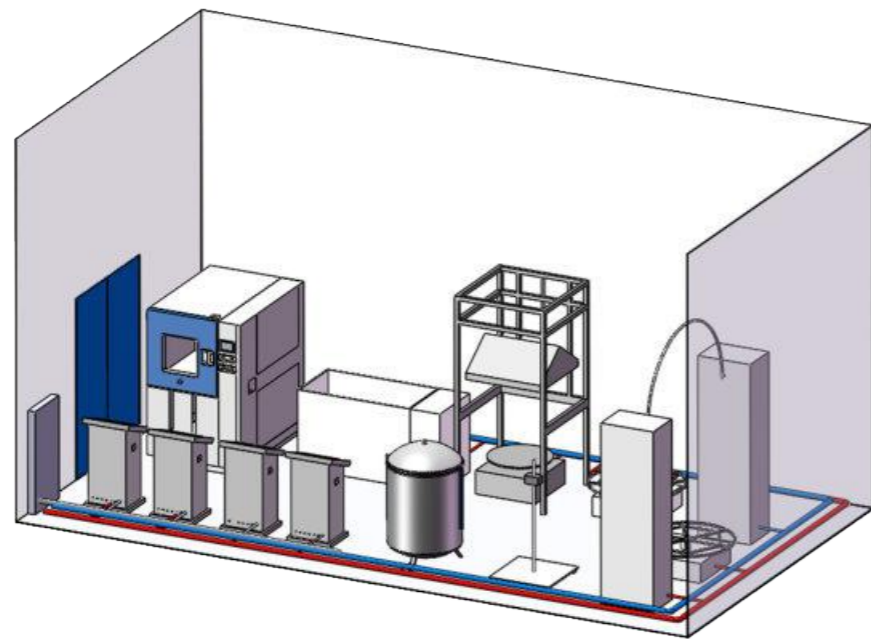

PRODUCT AND SERVICE

# Manufacturer And Supplier of Environmental Test Chamber

[www.lib-industry.com](http://www.lib-industry.com)